

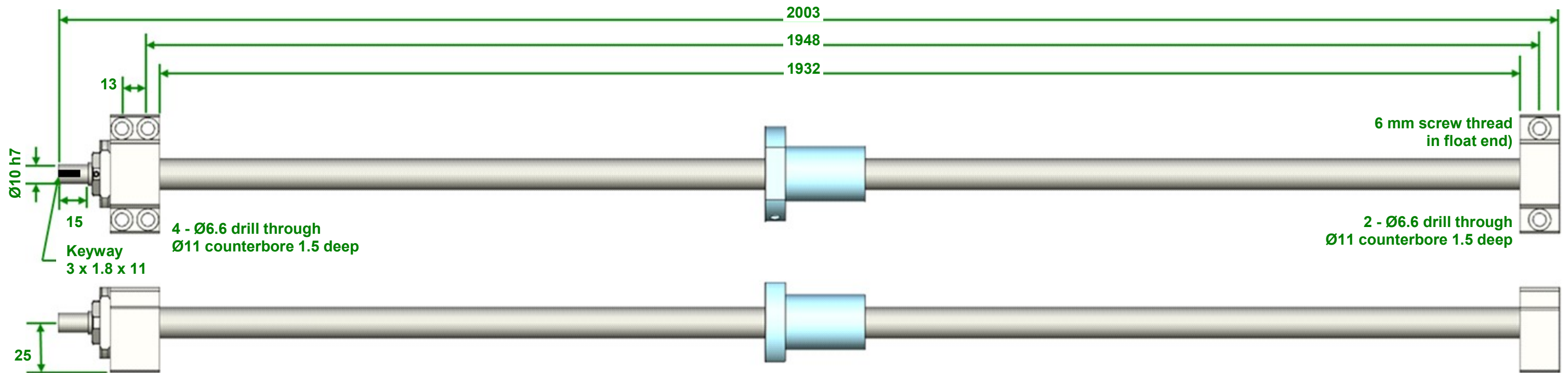

File Name:
F2RFU-1610-2000-BK12-BF12ASM_DATASHEET

Model Code:
F2RFU-1610-2000-BK12/BF12ASM

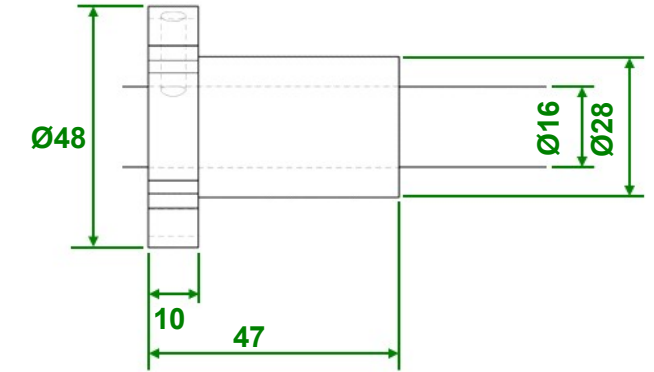
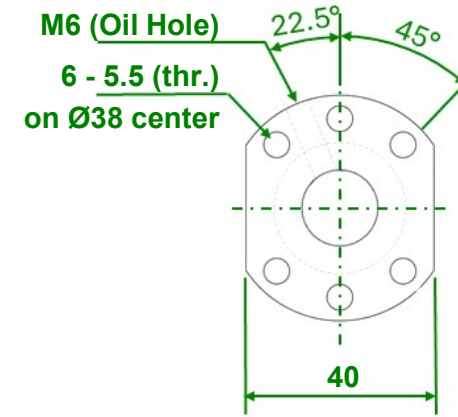

Ball Circle Diameter:	16 mm
Lead:	10 mm
Travel Variation (e300):	±50 µm / 300 mm
Backlash:	0.000 – 0.003
Hand Thread:	Right
C _{dyn} :	1590 lbs (12250 N)
C ₀ :	2754 lbs (7072 N)

Screw Cut Length:	2000 mm
Thread Length:	1938 mm
Nut Length:	47 mm
Max Stroke:	1885 mm

Units: mm

INSPIRE GREAT AUTOMATION



11970 Mayfield Livonia, MI 48150
(248) 798-4877
sales@fang2th.com