

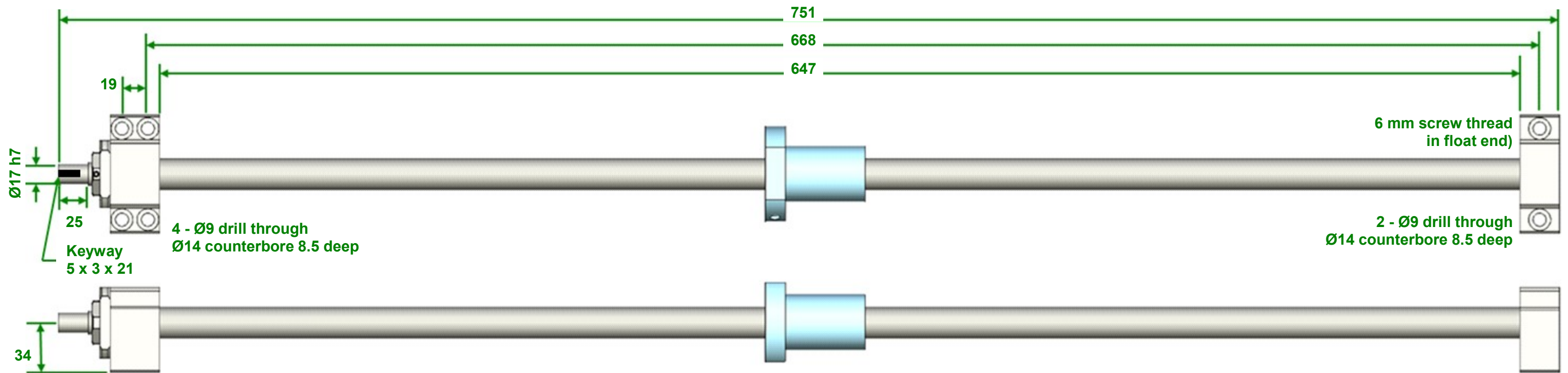

File Name:
F2RFU-2510-0750-BK20-BF20ASM_DATASHEET

Model Code:
F2RFU-2510-0750-BK20/BF20ASM

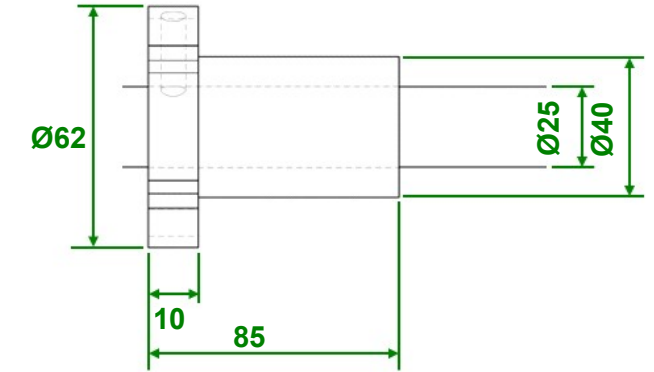
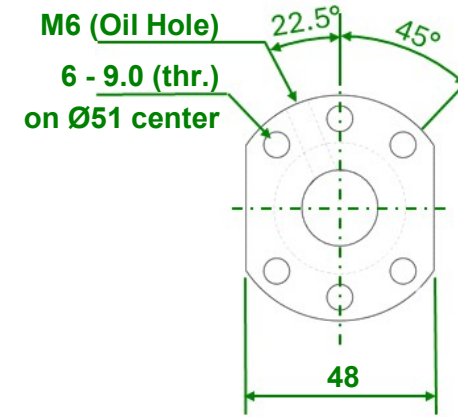

Ball Circle Diameter:	25 mm
Lead:	10 mm
Travel Variation (e300):	±50 µm / 300 mm
Backlash:	0.000 – 0.003
Hand Thread:	Right
C _{dyn} :	4287 lbs (38026 N)
C ₀ :	8549 lbs (19069 N)

Screw Cut Length:	750 mm
Thread Length:	653 mm
Nut Length:	85 mm
Max Stroke:	562 mm

Units: mm

INSPIRE GREAT AUTOMATION



11970 Mayfield Livonia, MI 48150
(248) 798-4877
sales@fang2th.com